

29MP Fixed Focal Length Lenses

Compatible with 8K line scan cameras



Product Features

- ▣ **High resolution**
Up to 100 lp/mm (full FOV)
- ▣ **Large image circle**
Compatible with 29MP full frame camera, and line scan camera up to 8K with 5μm pixel size
- ▣ **Low distortion**
Total distortion < 0.9%, and min. distortion as low as 0.03%

Resolution Comparison

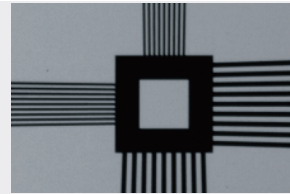

Image taken via OPT-F2528-29M

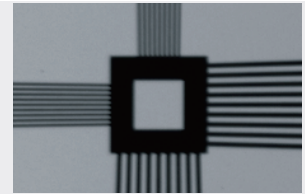
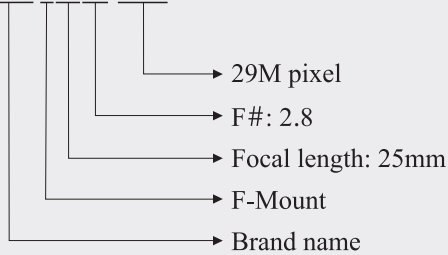

Image taken via other lens

Selection Guide

OPT-F2528-29M



Application Examples



Surface inspection for beverage can

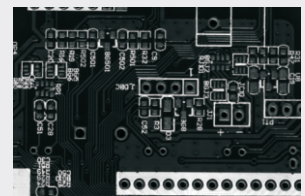

OCR for PCB



OCR for plastic parts



Dent detection on bearing

Model Table

No	Model	Focal length (mm)	Aperture range	WD (mm)	Filter thread (mm)	Distortion	Back focal length (mm)	Weight (kg)	Sensor format	FOV angle (H×V×D)		
1	OPT-F2528-29M	25	F2.8-F32	140-∞	M77×0.75	<0.9%	26.4	0.71	44mm	70.29°	55.67°	82.70°
									4/3"	39.60°	30.22°	48.46°
									1"	28.72°	21.74°	35.49°
2	OPT-F3528-29M	35	F2.8-F32	180-∞	M58×0.75	<0.4%	27.9	0.65	44mm	53.39°	41.33°	64.30°
									4/3"	28.84°	21.83°	35.64°
									1"	20.72°	15.62°	25.75°
3	OPT-F5028-29M	50	F2.8-F32	180-∞	M58×0.75	<0.2%	36.1	0.59	44mm	38.78°	29.58°	47.50°
									4/3"	20.41°	15.38°	25.36°
									1"	14.59°	10.97°	18.18°
4	OPT-F7528-29M	75	F2.8-F32	300-∞	M58×0.75	<0.03%	35.8	0.58	44mm	26.41°	19.96°	32.69°
									4/3"	13.69°	10.29°	17.06°
									1"	9.75°	7.32°	12.18°

MTF Charts

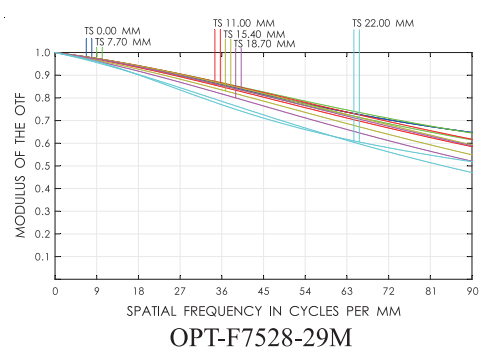
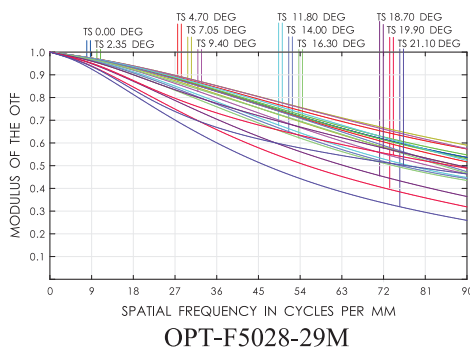
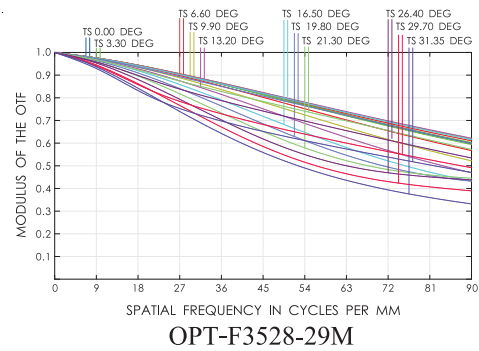
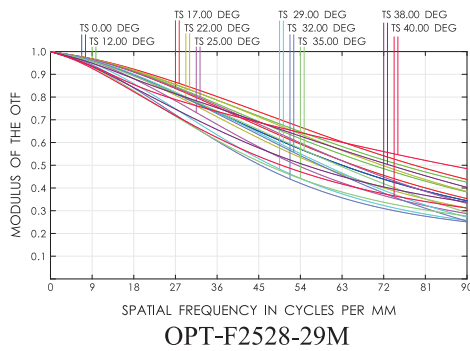

Dimensions (mm)

1. OPT-F2528-29M

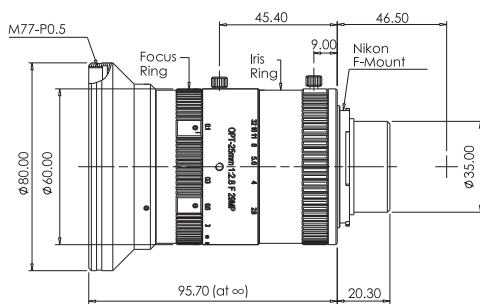

2. OPT-F3528-29M

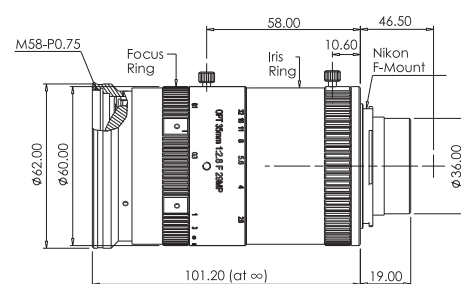

3. OPT-F5028-29M

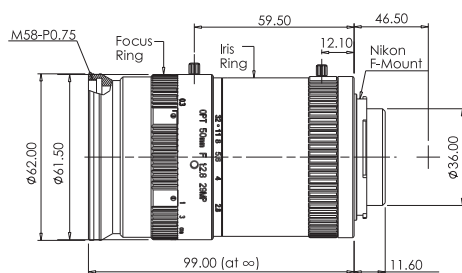

4. OPT-F7528-29M

